



modello:  
model:

**MERAK**

codice:  
code:

**6687**

design:

**U. T. Egoluce**

anno - year:

**2023**

tipologia:  
typology:

**faretto da incasso trimless**  
**trimless recessed spotlight**

materiali:  
materials:

**struttura in ferro zincato**  
**galvanized iron structure**

luce:

**diretta o diffusa**

light:

**direct or diffuse**

sorgente luminosa:  
light sources:

**6687 + COB LED**

LED code	optics		LED color
<b>0107/XW</b>	<b>/24 /40 /60</b>	6,2W 17,8V 350mA	896lm 2700K
<b>0107/WW</b>	<b>/24 /40 /60</b>	6,2W 17,8V 350mA	939lm 3000K
<b>0107/W</b>	<b>/24 /40 /60</b>	6,2W 17,8V 350mA	975lm 4000K
<b>0108/XW</b>	<b>/24 /40 /60</b>	9,2W 18,4V 500mA	1244lm 2700K
<b>0108/WW</b>	<b>/24 /40 /60</b>	9,2W 18,4V 500mA	1303lm 3000K
<b>0108/W</b>	<b>/24 /40 /60</b>	9,2W 18,4V 500mA	1353lm 4000K
<b>0108/XW/IP</b> (IP54)	<b>/24 /40 /60</b>	9,2W 18,4V 500mA	1244lm 2700K
<b>0108/WW/IP</b> (IP54)	<b>/24 /38 /58</b>	9,2W 18,4V 500mA	1303lm 3000K
<b>0108/W/IP</b> (IP54)	<b>/24 /38 /58</b>	9,2W 18,4V 500mA	1353lm 4000K

life

**> 50.000 h**

step MacAdam

**3**

Indice di Resa Cromatica:  
Color Rendering Index:

**>80** **CRI>90 su richiesta**  
**CRI>90 on request**

grado IP . IP grade:

**20**

finiture:

**.01 bianco**

finishes:

**.01 white**

peso netto - net weight:

**0,1 Kg**

marcatura:

**CE**

marking:

simboli costruttivi:



symbols:

### Dimensioni - Dimensions

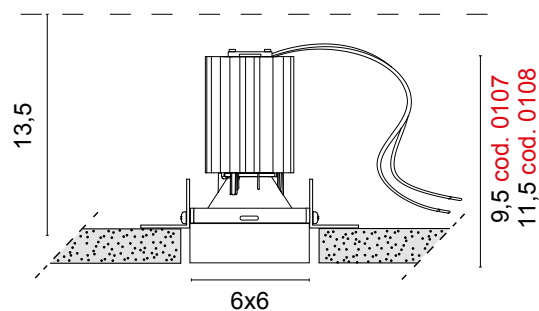

 6,2x6,2 cm

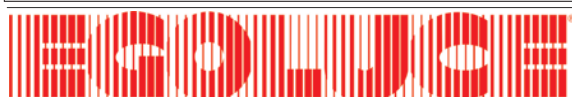

**LED DRIVERS** in corrente continua  
**LED DRIVERS** constant current**0125****LED driver**

IN: 100 - 240V  
OUT: 350 mA  
1 COB LED (art. 0107)



6 x 3,5 x 2 cm



SELV

**0128****LED driver**

IN: 100 - 240V  
OUT: 350 mA  
1-2 COB LED (art. 0107)

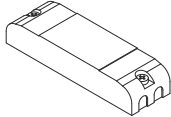

11,6 x 3,4 x 2 cm



SELV

**0136/15****LED driver**

IN: 100 - 240V  
OUT: 350 mA  
1-2 COB LED (art. 0107)

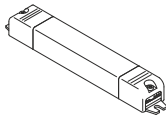

15,8 x 2,2 x 2 cm



SELV

**0169/50****Multipower LED driver**

IN: 220 - 240V  
OUT: 350mA  
1-3 COB LED (art. 0107)

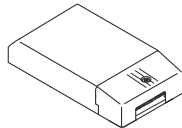

13 x 7,5 x 3 cm



SELV

**DRIVERS DIMMERABILI** in corrente continua  
**DIMMABLE LED DRIVERS** constant current**0129 Dimmer LED****Multipower dimmable driver**

IN: 110 - 240V  
OUT: 350 mA, 1-2 COB LED (art. 0107)

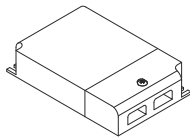

10,5 x 7 x 2,2 cm



SELV

**0129/DALI Dimmer LED****Multipower dimmable driver**

IN: 110 - 240V  
OUT: 350 mA 1-2 COB LED (art. 0107)

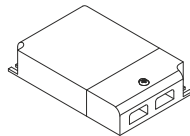

10,5 x 7 x 2,2 cm



SELV

**0141/DALI****LED driver**

IN: 110 - 240V  
OUT: 350 mA, 1-2 COB LED (art. 0107)

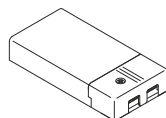

11,1 x 5,2 x 2,5 cm

 **0141/DIM****LED driver**

IN: 110 - 240V  
OUT: 350 mA, 1-2 COB LED (art. 0107)

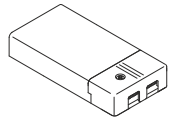
**Versione PUSH non sincronizzabile - PUSH version not synchronizable**

11,1 x 5,2 x 2,5 cm

 **0145 Dimmer LED Maxi**  
**Multipower dimmable driver**

IN: 110 - 240V  
OUT: 350 mA, 1-3 COB LED (art. 0107)

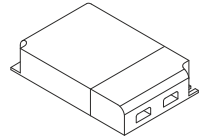

12,3 x 8 x 2,2 cm



SELV

**0145/DALI Dimmer LED Maxi**  
**Multipower dimmable driver**

IN: 110 - 240V  
OUT: 350 mA, 1-3 COB LED (art. 0107)

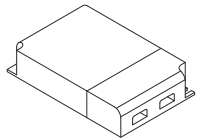

12,3 x 8 x 2,2 cm



SELV

**0133**

Cavo di sincronizzazione per dimmer LED  
Synchronization cable for dimmer LED  
(art. 0129 - art. 0129/DALI - art. 0145 - art. 0145/DALI)  
L 150 cm

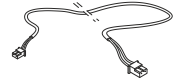
**0726/DIM****LED dimmer**

TAGLIO DI FASE (IGBT-TRIAC, TRAILING EDGE-LEADING EDGE)  
PHASE CUT-OFF (IGBT-TRIAC, TRAILING EDGE-LEADING EDGE)  
IN: 220 - 240V  
OUT: 24V - 20W  
350 mA, 1-2 COB LED (art. 0107)

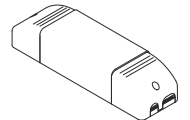

16,5 x 4,5 x 3,5 cm



SELV

**0733/DIM****LED dimmer**

Alimentatori elettronici dimmerabili (IGBT-TRIAC) in corrente continua  
Direct current dimmable (TRAILING EDGE-LEADING EDGE) electronic drivers  
IN: 220 - 240V  
OUT: 350 mA, 1 COB LED (art. 0107)

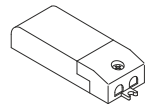

8,7 x 3,8 x 2,1 cm



IGBT-TRIAC SELV

**UNITA' DI EMERGENZA LED**  
**LED EMERGENCY UNIT****0115/EM****LED Emergency Unit**

Kit Inverter + Battery + LED indicator



15,5 x 5,2 x 2,5 cm

80 cm

13,5 x 4,5 x 2,3 cm



**LED DRIVERS** in corrente continua  
**LED DRIVERS** constant current**0127**

**LED driver**  
IN: 100 - 240V  
OUT: 500 mA  
1 COB LED (art. 0108)

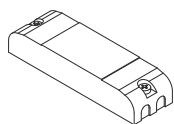

11,6 x 3,4 x 2 cm 4 cm

**0147/COB**

**LED driver**  
IN: 220 - 240V  
OUT: 500 mA  
1-2 COB LED (art. 0108)

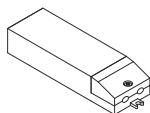

12,5 x 3,8 x 2,4 cm 4,2 cm

**0149/COB**

**LED driver**  
IN: 220 - 240V  
OUT: 500 mA  
1 COB LED (art. 0108)

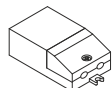

7,6 x 3,9 x 2,2 cm 4,2 cm

**0169/50**

**Multipower LED driver**  
IN: 220 - 240V  
OUT: 500mA  
1-3 COB LED (art. 0108)

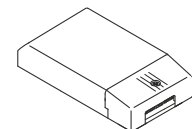

13 x 7,5 x 3 cm 8,5 cm

**DRIVERS DIMMERABILI** in corrente continua  
**DIMMABLE LED DRIVERS** constant current**0129 Dimmer LED**

**Multipower dimmable driver**  
IN: 110 - 240V  
OUT: 500 mA, 1-2 COB LED (art. 0108)

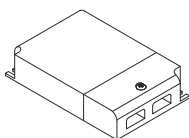

10,5 x 7 x 2,2 cm 7,2 cm SELV

**0129/DALI Dimmer LED**

**Multipower dimmable driver**  
IN: 110 - 240V  
OUT: 500 mA, 1-2 COB LED (art. 0108)

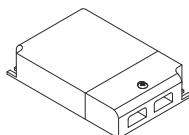

10,5 x 7 x 2,2 cm 7,2 cm SELV

**0141/DALI**

**LED driver**  
IN: 110 - 240V  
OUT: 500 mA, 1-2 COB LED (art. 0108)

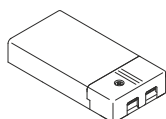

11,1 x 5,2 x 2,5 cm 5,5 cm

**0141/DIM**

**LED driver**  
IN: 110 - 240V  
OUT: 500 mA, 1-2 COB LED (art. 0108)

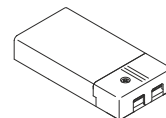

Versione PUSH non sincronizzabile - PUSH version not synchronizable

11,1 x 5,2 x 2,5 cm 5,5 cm

**0145 Dimmer LED Maxi**  
**Multipower dimmable driver**

IN: 110 - 240V  
OUT: 500 mA, 1-3 COB LED (art. 0108)

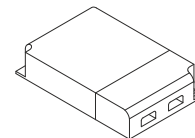

12,3 x 8 x 2,2 cm 8,4 cm SELV

**0145/DALI Dimmer LED Maxi**  
**Multipower dimmable driver**

IN: 110 - 240V  
OUT: 500 mA, 1-3 COB LED (art. 0108)

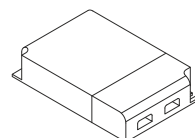

12,3 x 8 x 2,2 cm  
 8,4 cm SELV

**0133**

Cavo di sincronizzazione per dimmer LED  
Synchronization cable for dimmer LED  
(art. 0129 - art. 0129/DALI - art. 0145 - art. 0145/DALI)



L 150 cm

**0726/DIM**

**LED dimmer**  
TAGLIO DI FASE (IGBT-TRIAC, TRAILING EDGE-LEADING EDGE)  
PHASE CUT-OFF (IGBT-TRIAC, TRAILING EDGE-LEADING EDGE)  
IN: 220 - 240V  
OUT: 24V - 20W  
500 mA, LED, 1-2 COB LED (art. 0108)

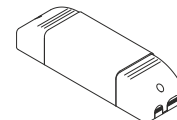

16,5 x 4,5 x 3,5 cm 5,6 cm IGBT-TRIAC SELV

**0734/DIM**

**LED dimmer**  
Alimentatori elettronici dimmerabili (IGBT-TRIAC) in corrente continua  
Direct current dimmable (TRAILING EDGE-LEADING EDGE) electronic drivers  
IN: 220 - 240V  
OUT: 500 mA, 1 COB LED (art. 0108)

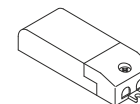

8,7 x 3,8 x 2,1 cm 4,2 cm IGBT-TRIAC SELV

**UNITA' DI EMERGENZA LED**  
**LED EMERGENCY UNIT****0115/EM**

**LED Emergency Unit**  
Kit Inverter + Battery + LED indicator



15,5 x 5,2 x 2,5 cm      80 cm      13,5 x 4,5 x 2,3 cm

