



Accessori e rosoni per sistemi a sospensione a 230V

*Accessories and ceiling roses
for suspension systems 230V*

Accessori - rosoni lampada singola - **Accessories** - singol lamp ceiling rose



0607

Rosone 1 uscita laterale

1 Lampada - 50/60Hz 220-240V

Ceiling rose 1 side hole

1 Lamp - 50/60Hz 220-240V

.01 Bianco - *White*

.02 Nero - *Black*

.35 Sabbia - *Sand*



Ø 9,3



0,20 Kg

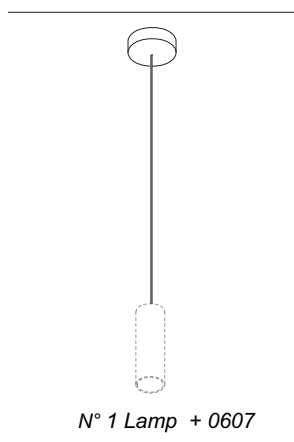

0605

Deviatore e decentratore - Ø 1,7 H 2,2
Displacement element - Ø 1,7 H 2,2

.01 Bianco - *White*

.02 Nero - *Black*



EGOLUCE s.r.l., via I. Newton 12 - 20016 Pero - Milano
telefono +39 02 339586.1 - fax. +39 02 3535112
e-mail: info@egoluce.com - <http://www.egoluce.com>

La presente scheda tecnica è di proprietà di EGOLUCE srl. Tutti i diritti sono riservati. Le fotografie, le descrizioni degli apparecchi, disegni quotati ed i valori fotometrici menzionati sono a titolo indicativo e non costituiscono alcun impegno per la nostra società che si riserva di apportare, in qualsiasi momento e senza preavviso, tutte le modifiche che riterrà opportune.

Accessori - rosoni lampada singola - Accessories - singol lamp ceiling rose**0604**

Rosone 1 uscita laterale
1 Lampada - 50/60Hz 220-240V

Ceiling rose 1 side hole
1 Lamp - 50/60Hz 220-240V

.01 Bianco - *White*
.02 Nero - *Black*

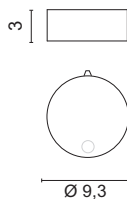

0,15 Kg

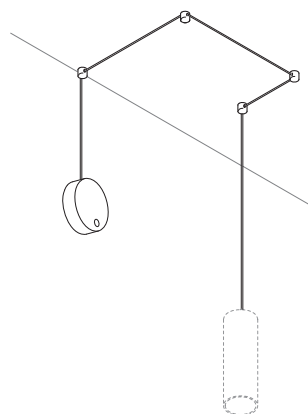

N° 1 Lamp + 0604 + N° 4 art. 0605

**0947**

Piastra con molle per controsoffitti
 Ceiling plate with springs

.01 Bianco - *White*
.02 Nero - *Black*
.35 Sabbia - *Sand*

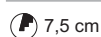
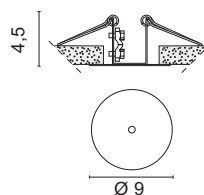

7,5 cm

0,08 Kg



N° 1 Lamp + 0947

**0605**

Deviatore e decentratore - Ø 1,7 H 2,2
 Displacement element - Ø 1,7 H 2,2

.01 Bianco - *White*
.02 Nero - *Black*



EGOLUCE s.r.l., via I. Newton 12 - 20016 Pero - Milano
 telefono +39 02 339586.1 - fax. +39 02 3535112
 e-mail: info@egoluce.com - http://www.egoluce.com

Accessori - rosoni tondi multipli - Accessories - rounded ceiling rose**0600**

Rosone per sospensione
3 Lampade - 50/60Hz 220-240V

Ceiling rose for suspension
3 Lamps - 50/60Hz 220-240V

.01 Bianco - *White*
.02 Nero - *Black*
.35 Sabbia - *Sand*

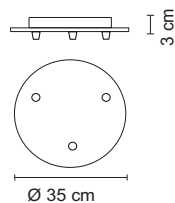

F 0,50 Kg

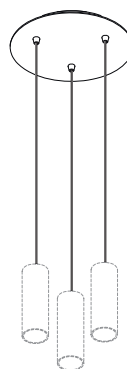

N° 3 lamps + 0600

0601

Rosone per sospensione
5 Lampade - 50/60Hz 220-240V

Ceiling rose for suspension
5 Lamps - 50/60Hz 220-240V

.01 Bianco - *White*
.02 Nero - *Black*
.35 Sabbia - *Sand*

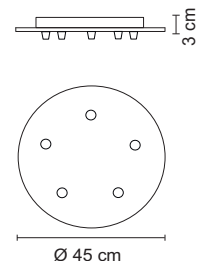

F 1,70 Kg

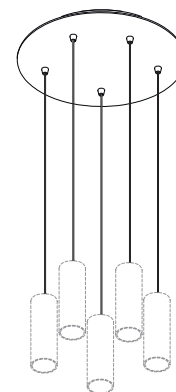

N° 5 lamps + 0601



Accessori - rosoni quadrati multipli - Accessories - square ceiling rose



0978/2

2 Kg

Rosone per sospensione
- 2 Lampade - 50/60Hz 220-240V

Ceiling rose for suspension
- 2 Lamps - 50/60Hz 220-240V

.01 Bianco - White

.02 Nero - Black

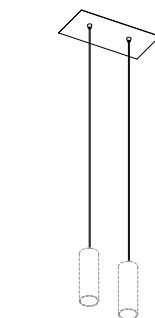
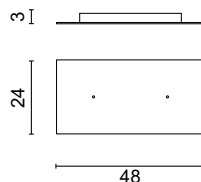

N° 2 lamps + 0978/2

0978/4

3,8 Kg

Rosone per sospensione
- 4 Lampade - 50/60Hz 220-240V

Ceiling rose for suspension
- 4 Lamps - 50/60Hz 220-240V

.01 Bianco - White

.02 Nero - Black

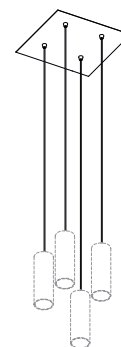
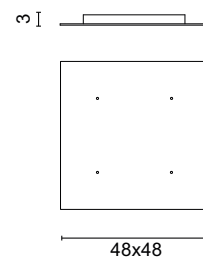

N° 4 lamps + 0978/4

Esempio di installazione multipla. - Example of multiple installation.

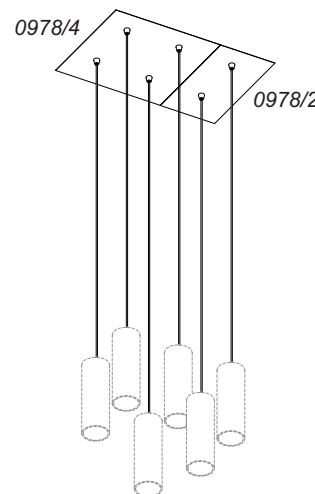
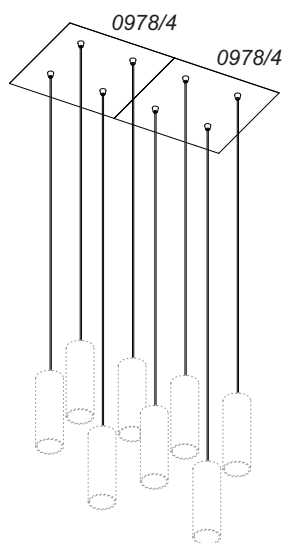
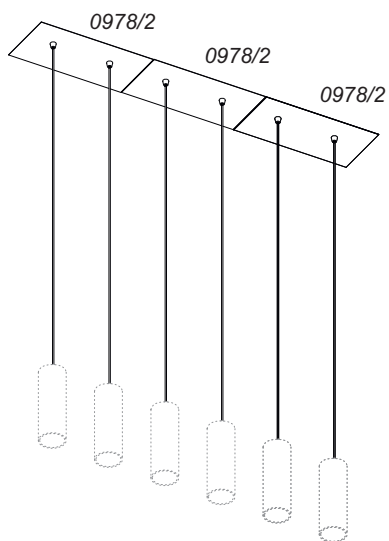

EGOLUCE s.r.l., via I. Newton 12 - 20016 Pero - Milano
 telefono +39 02 339586.1 - fax. +39 02 3535112
 e-mail: info@egoluce.com - http://www.egoluce.com

La presente scheda tecnica è di proprietà di EGOLUCE srl. Tutti i diritti sono riservati. Le fotografie, le descrizioni degli apparecchi, disegni quotati ed i valori fotometrici menzionati sono a titolo indicativo e non costituiscono alcun impegno per la nostra società che si riserva di apportare, in qualsiasi momento e senza preavviso, tutte le modifiche che riterrà opportune.

Accessori - rosoni tondi multipli con uscita cavi radiali - Accessories - rounded ceiling rose with radial cable exit



0603
 Rosone per sospensione
1 - 4 lampade - 50/60Hz 220-240V
 Ceiling rose for suspension
1 - 4 lamps - 50/60Hz 220-240V
 .01 Bianco - White
 .02 Nero - Black

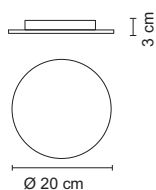

F 0,50 Kg



0602
 Rosone per sospensione
1 - 12 lampade - 50/60Hz 220-240V
 Ceiling rose for suspension
1 - 12 lamps - 50/60Hz 220-240V
 .01 Bianco - White
 .02 Nero - Black

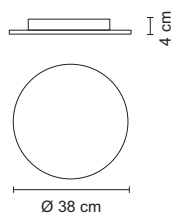

F 1,70 Kg

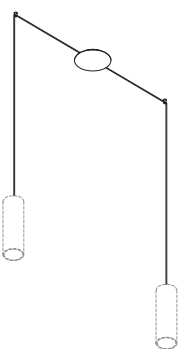

N° 2 lamps + 0603

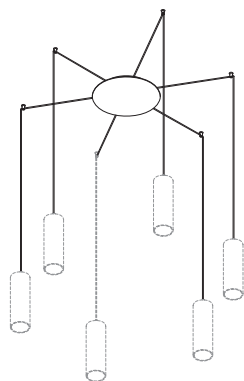

N° 6 lamps + 0602

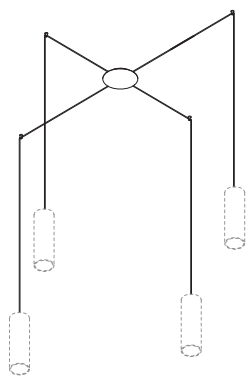

N° 4 lamps + 0603

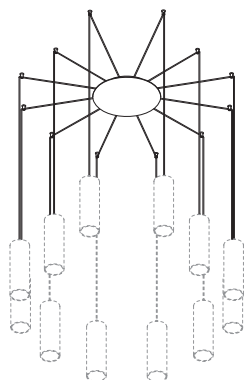

N° 12 lamps+ 0602

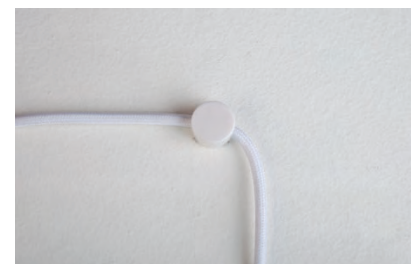
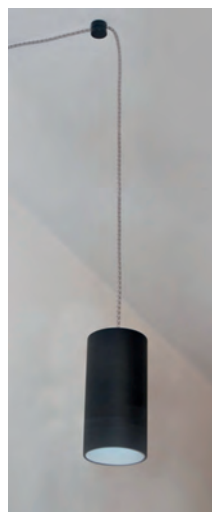

0605
 Deviatore e decentratore - Ø 1,7 H 2,2
 Displacement element - Ø 1,7 H 2,2
 .01 Bianco - White
 .02 Nero - Black



EGOLUCE s.r.l., via I. Newton 12 - 20016 Pero - Milano
 telefono +39 02 339586.1 - fax. +39 02 3535112
 e-mail: info@egoluce.com - http://www.egoluce.com

La presente scheda tecnica è di proprietà di EGOLUCE srl. Tutti i diritti sono riservati. Le fotografie, le descrizioni degli apparecchi, disegni quotati ed i valori fotometrici menzionati sono a titolo indicativo e non costituiscono alcun impegno per la nostra società che si riserva di apportare, in qualsiasi momento e senza preavviso, tutte le modifiche che riterrà opportune.

Accessori - rosoni lineari - Accessories - linear ceiling rose

**0613/3**

- | | |
|-----|----------------|
| .01 | Bianco - White |
| .02 | Nero - Black |
| .35 | Sabbia - Sand |

Rosone lineare - **3 lampade**
 Linear ceiling rose - **3 lamps**
 50/60Hz 220-240V



1,10 Kg

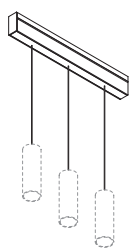
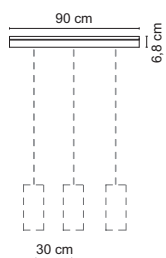

N° 3 lamps + 0613/3 ...

0613/4

- | | |
|-----|----------------|
| .01 | Bianco - White |
| .02 | Nero - Black |
| .35 | Sabbia - Sand |

Rosone lineare - **4 lampade**
 Linear ceiling rose - **4 lamps**
 50/60Hz 220-240V



1,30 Kg

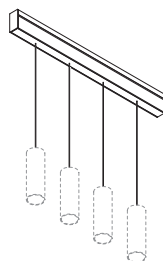
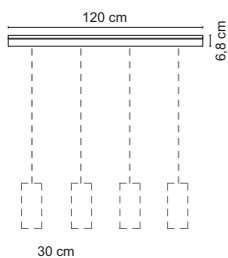

N° 4 lamps + 0613/4 ...

0613/6

- | | |
|-----|----------------|
| .01 | Bianco - White |
| .02 | Nero - Black |
| .35 | Sabbia - Sand |

Rosone lineare - **6 lampade**
 Linear ceiling rose - **6 lamps**
 50/60Hz 220-240V



1,50 Kg

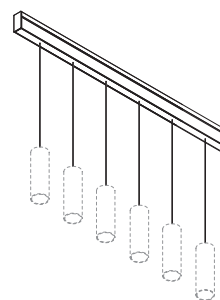
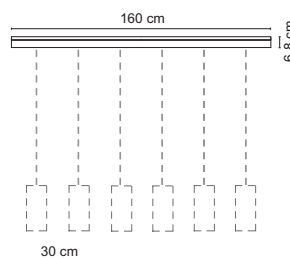

N° 6 lamps + 0613/6 ...



La presente scheda tecnica è di proprietà di EGOLUCE srl. Tutti i diritti sono riservati. Le fotografie, le descrizioni degli apparecchi, disegni quotati ed i valori fotometrici menzionati sono a titolo indicativo e non costituiscono alcun impegno per la nostra società che si riserva di apportare, in qualsiasi momento e senza preavviso, tutte le modifiche che riterrà opportune.

EGOLUCE s.r.l., via I. Newton 12 - 20016 Pero - Milano
 telefono +39 02 339586.1 - fax. +39 02 3535112
 e-mail: info@egoluce.com - http://www.egoluce.com