

Accessori - rosoni tondi multipli con uscita cavi radiali - Accessories - rounded ceiling rose with radial cable exit

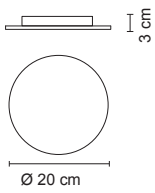

0603
Rosone per sospensione
1 - 4 ampade - 50/60Hz 220-240V

Ceiling rose for suspension
DS - 50/60Hz 220-240V
.01 Bianco - *White*
.02 Nero - *Black*



F 0,50 Kg



0602
Rosone per sospensione
1 - 12 ampade - 50/60Hz 220-240V

Ceiling rose for suspension
DS - 50/60Hz 220-240V
.01 Bianco - *White*
.02 Nero - *Black*

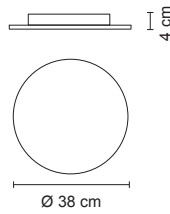

F 1,70 Kg



N° 3 lamps + 0602.01

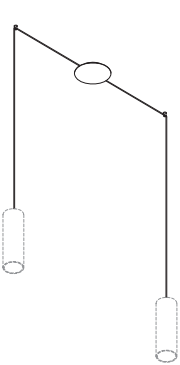

N° 2 lamps + 0603

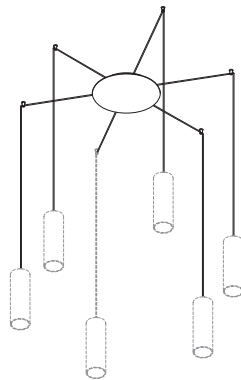

N° 6 lamps + 0602

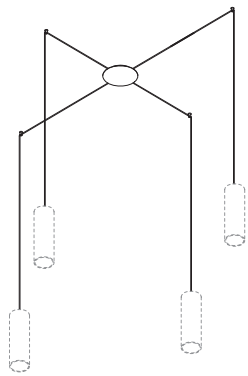

N° 4 lamps + 0603

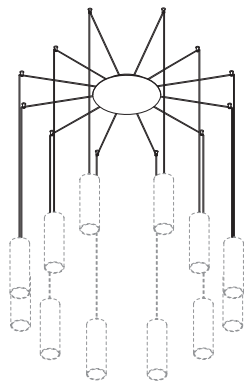

N° 12 lamps+ 0602

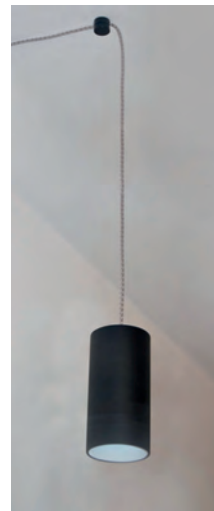

0605
Deviatore e decentratore - Ø 1,7 H 2,2
Displacement element - Ø 1,7 H 2,2

.01 Bianco - *White*
.02 Nero - *Black*



Accessori - rosoni lineari - Accessories - linear ceiling rose



N° 3 lamps + 0559/3.01

0613/3

- .01** Bianco - White
- .02** Nero - Black
- .35** Sabbia - Sand

Rosone lineare - **3 Lampade**
Linear ceiling rose - **3 Lamps**

50/60Hz 220-240V

 1,10 Kg

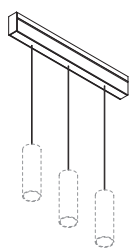
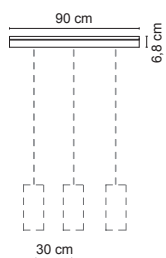

N° 3 lamps + 0613/3 ...

0613/4

- .01** Bianco - White
- .02** Nero - Black
- .35** Sabbia - Sand

Rosone lineare - **4 Lampade**
Linear ceiling rose - **4 Lamps**

50/60Hz 220-240V

 1,30 Kg

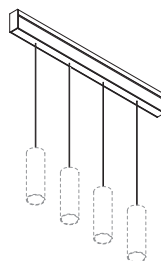
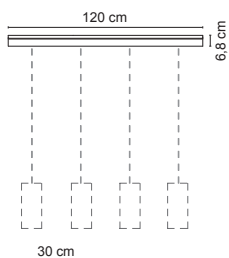

N° 4 lamps + 0613/4 ...

0613/6

- .01** Bianco - White
- .02** Nero - Black
- .35** Sabbia - Sand

Rosone lineare - **6 Lampade**
Linear ceiling rose - **6 Lamps**

50/60Hz 220-240V

 1,50 Kg

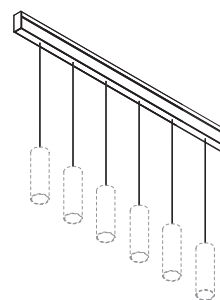
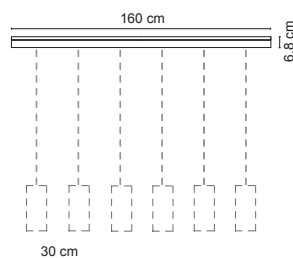

N° 6 lamps + 0613/6 ...



EGOLUCE s.r.l., via I.Newton 12 - 20016 Pero - Milano
telefono +39 02 339586.1 - fax. +39 02 3535112
e-mail: info@egoluce.com - http://www.egoluce.com